

INSTRUCTION MANUAL

 **BK PRECISION®**

MODEL 1711

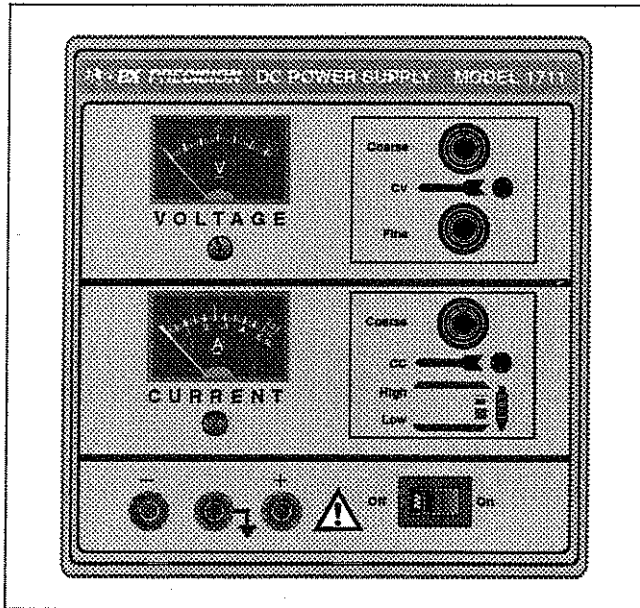

0-60V, 0-2A DC POWER SUPPLY

 **BK PRECISION®**

**Instruction Manual
For
Model 1711
0-60V, 0-2A
DC POWER SUPPLY**



BK PRECISION®

6470 W. Cortland St. • Chicago, IL 60707-4098

TABLE OF CONTENTS

	page		page
TEST INSTRUMENT SAFETY	inside front cover	APPLICATIONS	19
INTRODUCTION	3	General	19
FEATURES	4	Electronics Servicing	19
SPECIFICATIONS	5	Electronics Manufacturing	19
CONTROLS AND INDICATORS	7	Electronics Design Lab	20
OPERATING INSTRUCTIONS	9	Electronics Education	20
Safety Precautions	9	Battery Charging	20
Equipment Precautions	9	MAINTENANCE	21
Hook-Up	9	Fuse Replacement	21
Typical Constant Voltage Operation	12	Line Voltage Conversion, International Units	21
Setting Current Limit	13	Adjustments	21
Typical Constant Current Operation	14	1711 Calibration	23
Constant Voltage/Constant Current Characteristic	15	Instrument Repair Service	23
Connecting Two Power Supplies in Series	15	WARRANTY SERVICE INSTRUCTIONS	27
Connecting Two Power Supplies in Parallel	18	LIMITED TWO-YEAR WARRANTY	28

INTRODUCTION

The **B+K Precision** Model 1711 DC Power Supply is a high quality general purpose dc power source. The power supply provides 0-60 volts dc output, adjustable with both coarse and fine controls for precise settability. The current output of the Model 1711 is 0-2 amps. Two current ranges, High and Low, provide excellent current settability and meter resolution. Two large panel-mounted meters continuously monitor the output voltage and current.

The power supply exhibits excellent regulation and low ripple characteristics. The circuit design incorporates a pre-regulator, which greatly reduces internal power dissipation at low output voltages. The styling is both attractive and functional. The mechanical configuration conserves bench space and allows for easy portability.

The instrument may be used in constant voltage or constant current applications. The crossover from constant voltage to constant current modes is smooth and automatic. LED's indicate the "CV" (constant voltage) or "CC" (constant current) mode of operation. In constant voltage applications, a current limit may be preset. When load variations cause the current to reach the preset limit, the unit then regulates output

current rather than output voltage. Current limits are adjustable from 5% to 100% of maximum. In constant current applications, the maximum voltage may be preset. When load variations cause current to drop below the regulated value, the unit reverts to regulated voltage operation at the preset value.

Reverse polarity protection prevents accidental damage to the power supply from improper connection to an external voltage, and current limiting protects the equipment being powered, as well as the power supply.

The output is isolated from chassis and earth ground, which permits full flexibility of connections. When needed, the (+) or (-) polarity may be strapped to ground, or either polarity may be floated to an external voltage. Two supplies may be connected in series as a 0-to-120 volt power source, or two supplies may be connected in parallel, with suitable balancing resistors, for up to twice the output current.

The power supply is well suited for a wide variety of electrical and electronics applications, including service shops, engineering labs, production testing, school laboratories, and home use by hobbyists.

FEATURES

0-60 VOLTS

Continuously variable over 0-to-60 volt range with coarse and fine controls.

0-2 AMPS

0-to-2 amps available. Rated for continuous duty at full output current.

LABORATORY QUALITY

Excellent regulation, low ripple.

CONSTANT VOLTAGE OR CONSTANT CURRENT

Provides regulated dc voltage output or regulated dc current output. Crossover is smooth and automatic.

TWO CURRENT RANGES

High-Low switch selects full output (0-2 A), or one quarter output (0-0.5 A). Low range improves current settability and meter resolution at lower current values. Switch simultaneously selects range of adjustment and corresponding meter scale.

BUILT-IN METERING

Two large, easy-to-read meters continuously monitor output voltage and current.

LED INDICATORS

Act as pilot light and identify mode of operation.

PRE-REGULATOR

Limits internal dissipation for higher reliability.

ISOLATED OUTPUT

Either polarity may be floated or grounded.

OVERLOAD PROTECTION

Fully adjustable current limiting (from 5% to 100% of maximum output current) protects circuit under test and the power supply.

REVERSE POLARITY PROTECTION

Prevents damage to power supply from external voltage of reverse polarity.

STYLING

Modern functional styling. Configuration conserves bench space and aids portability. Logical, convenient layout of controls.

SPECIFICATIONS

OUTPUT VOLTAGE

0 to 60 VDC, coarse and fine adjustment

OUTPUT CURRENT

High Range — 0 to 2 A

Low Range — 0 to 0.5 A

CONSTANT VOLTAGE OPERATION

Voltage Regulation

Line (108- 132) $\leq 0.01\% + 3$ mV

Load (no load to full load) $\leq 0.01\% + 5$ mV

Recovery Time ≤ 100 μ s typical

Ripple Voltage

RMS ≤ 1 mV

Temperature Coefficient

0° to +40° C ≤ 300 PPM/° C

CONSTANT CURRENT OPERATION

Adjustable Current Limits

5% to 100%

Current Regulation

Line (108-132 V) $\leq 0.2\% + 3$ mA

Load $\leq 0.2\% + 3$ mA

Current Ripple ≤ 3 mA typical

METERING

Voltmeter

Range 0 to 64 V

Accuracy $\pm 2.5\%$

Ammeter

Hi Range 0 to 2.2 A

Lo Range 0 to 0.55A

Accuracy $\pm 2.5\%$

POWER REQUIREMENTS

Domestic: 120 VAC $\pm 10\%$, 60 Hz

International: 120, 220, 230, 240 VAC $\pm 10\%$, 50/60 Hz

POWER CONSUMPTION

Approximately 210 Watts or less at full load

PROTECTION

Reverse polarity protection; current limiting

TEMPERATURE RANGE

Operation 0° to +25° C $\leq 75\%$ R.H., Full Load

+25° C to +40° C $\leq 75\%$ R.H. Partial Load

Maximum Current derated 0.05 A per degree C above +25° C.

Storage -15° to +70° C $\leq 85\%$ R.H.

SPECIFICATIONS

DIMENSIONS (H x W x D)

6.5 x 5.5 x 12.5

WEIGHT

12 lb

ACCESSORIES SUPPLIED

Spare Fuse

Instruction Manual

CONTROLS AND INDICATORS

INDICATORS

Either the "CC" or "CV" indicator will be lighted whenever the unit is operating, thus serving as a pilot light. The unit automatically changes from CV to CC operation when the preset current limit is reached.

1. **C.C. (Constant Current) Indicator.** Red LED lights in constant current mode. Unit regulates output current at value set by CURRENT controls.
2. **C.V. (Constant Voltage) Indicator.** Green LED lights in constant voltage mode. Unit regulates output voltage at value set by VOLTAGE controls.

VOLTAGE CONTROLS

3. **Coarse Control.** Coarse adjustment of output voltage. Read value on \underline{V} meter.
4. **Fine Control.** Fine adjustment of output voltage. Read value on \underline{V} meter.

CURRENT CONTROLS

5. **CURRENT Control.** Adjusts current limit in constant voltage mode. Adjusts constant current value in constant current mode. Range of adjustment is determined by High-Low switch.

6. **High-Low Switch.** High position selects high current range; value is read on top meter scale of Δ meter. Low position selects low current range; value is read on bottom meter scale of Δ meter.

High	0 to 2 A
Low	0 to 0.5 A

POWER CONTROLS

7. **ON-OFF Switch.**

OUTPUT TERMINALS

8. **"+" Terminal (Red).** Positive polarity output terminal.
9. **$\frac{1}{\text{E}}$ Terminal (Green).** Earth and chassis ground.
10. **"-" Terminal (Black).** Negative polarity output terminal.

METERS

11. **Δ Meter.** Reads output current in amperes. Use top scale when High-Low switch is set to High, bottom scale when switch is set to Low.
12. **\underline{V} Meter.** Reads output voltage on 0 to 64 V scale.

REAR PANEL CONTROLS

13. **Fuse.**
14. **Power Cord.**

OPERATING INSTRUCTIONS

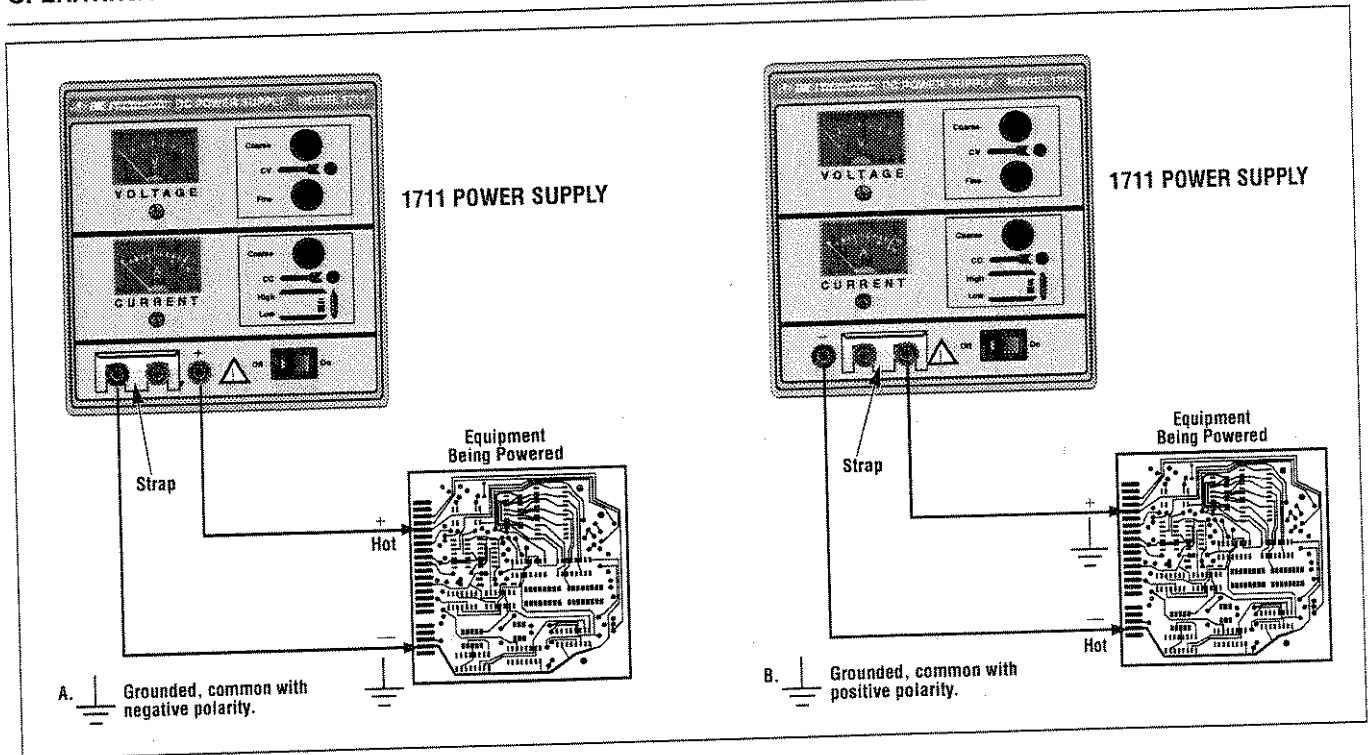

Figure 3 (A and B). Grounding Possibilities.

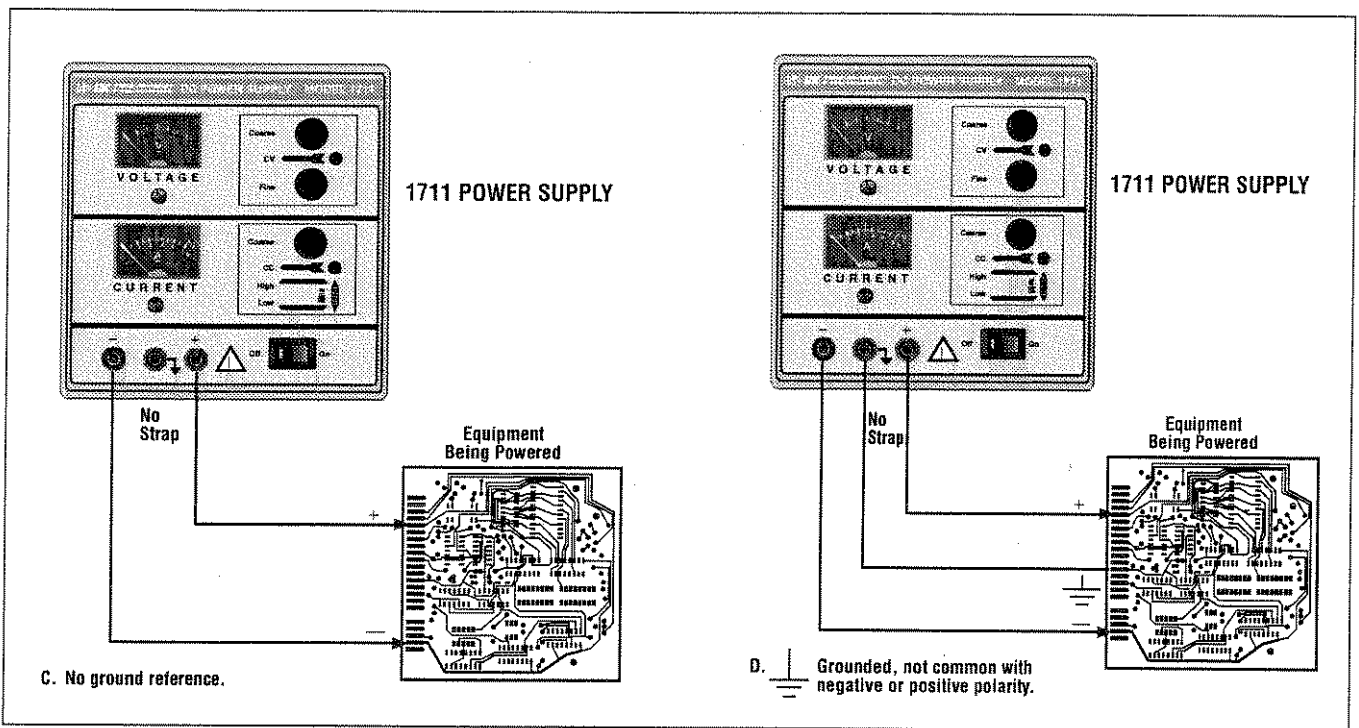

Figure 3 (C and D). Grounding Possibilities.

OPERATING INSTRUCTIONS

- d. If the chassis or common of the equipment being powered is separate from both the positive and negative polarity power inputs, use the connection shown in Fig. 3D.
5. Observe proper polarity. If the circuit being powered is not equipped with reverse polarity protection, damage to the circuit can result from reverse polarity. Use color coded hook-up leads, such as the set supplied with the power supply, for convenience in identifying polarity, red for (+) and black for (-).
6. Make sure that the hook-up leads offer sufficient current capability and low resistance between the power supply and the circuits being powered.

TYPICAL CONSTANT VOLTAGE OPERATION

1. Before connecting the device to be powered to the power supply, determine the maximum safe load current for the device to be powered and set the current limit value (see "Setting Current Limit" procedure in this section).
2. Set Fine VOLTAGE control to center and Coarse VOLTAGE control to minimum (fully counterclockwise).
3. Turn off power supply and connect it to the device to be powered (see "Hook-Up" procedure in this section).
4. Turn on POWER switch. The CV indicator should light.
5. Increase the VOLTAGE setting until the ∇ meter reads the desired value. The Fine control permits easier setting to a specific value.
6. Note the load current on the Δ meter.

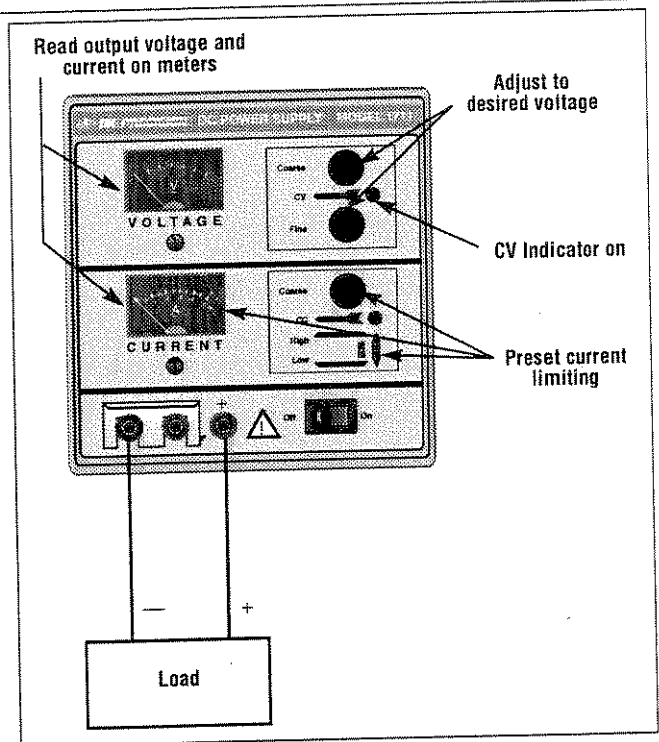

Figure 4. Typical Constant Voltage Operation.

7. If the load current exceeds the preset current limit, the CV indicator will go off and the CC indicator will light. In this case, the power supply automatically switches to the constant current mode, and further rotation of the VOLTAGE control will not increase the output voltage as read on the ∇ meter.

SETTING CURRENT LIMIT

1. Determine the maximum safe current value for the device to be powered. If the value is greater than 0.5 A then set the High-Low switch to High. If the value is less than 0.5 A then set the High-Low switch to Low.
2. Temporarily short the (+) and (-) terminals of the power supply together with a test lead.
3. Rotate the Coarse VOLTAGE control away from zero sufficiently for the CC indicator to light.
4. Adjust the Coarse CURRENT control for the desired current limit. Read the current value on the Δ meter.
5. The current limit (overload protection) has now been preset. Do not change the Coarse CURRENT control setting after this step.
6. Remove the short between the (+) and (-) terminals and hook up for constant voltage operation.

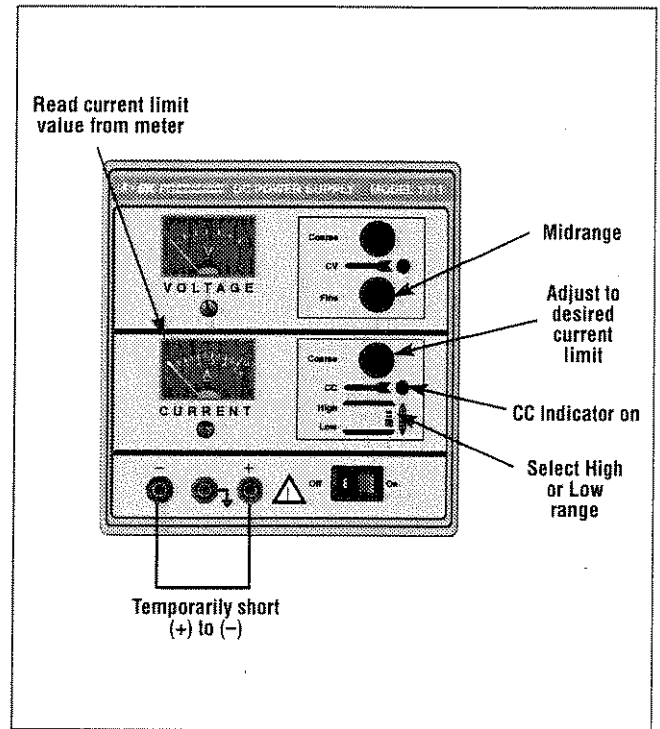

Figure 5. Setting Current Limit.

OPERATING INSTRUCTIONS

TYPICAL CONSTANT CURRENT OPERATION

1. Before connecting the device to be powered to the power supply, determine the maximum safe voltage to be applied and set the VOLTAGE controls to obtain that voltage reading on the ∇ meter.
2. Determine the desired constant current value. If the value is greater than 0.5 A, set the High-Low switch to High. If the value is less than 0.5 A, set the High-Low switch to Low.
3. Set the CURRENT control to minimum (fully counterclockwise).
4. Turn off the power supply and connect it to the device to be powered.
5. Turn on the power supply. The CC indicator should light.
6. Increase the CURRENT control setting until the desired constant current value is read on the Δ meter, or set the current limit in advance (before connecting the load) as prescribed in the earlier "Setting Current Limit" procedure.
7. If the load current drops below the constant current value, the CC indicator will go off and the CV indicator will light. In this case, the power supply automatically switches to the constant voltage mode, and further rotation of the CURRENT control will not increase the output current as read on the Δ meter.

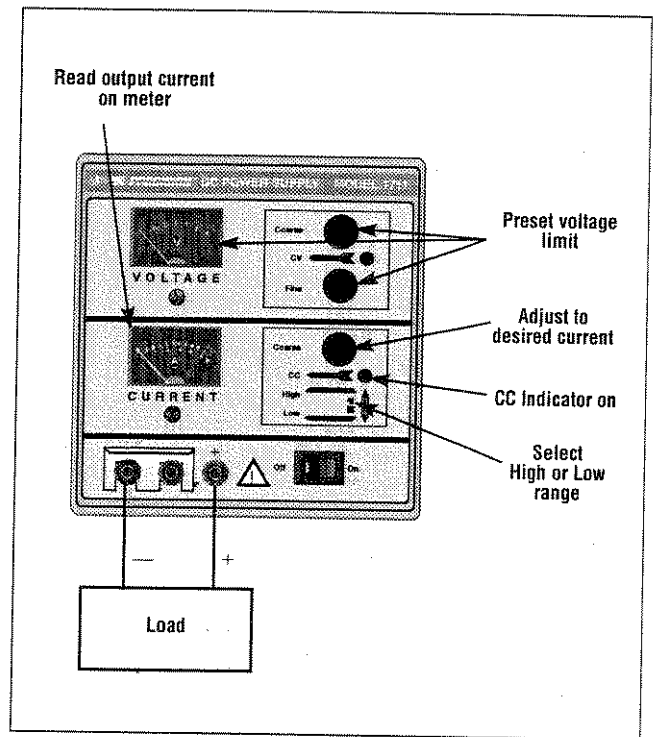

Figure 6. Typical Constant Current Operation.

CONSTANT VOLTAGE/CONSTANT CURRENT CHARACTERISTIC

The working characteristic of the Model 1711 Power Supply is called a constant voltage/constant current automatic crossover type. This permits continuous transition from constant current to constant voltage modes in response to the load change. The intersection of constant voltage and constant current modes is called the crossover point. Fig. 7 shows the relationship between this crossover point and the load.

For example, if the load is such that the power supply is operating in the constant voltage mode, a regulated output voltage is provided. The output voltage remains constant as the load increases, up until the point where the preset current limit is reached. At that point, the output current becomes constant and the output voltage drops in proportion to further increases in load. The crossover point is indicated by the front panel LED indicators. The crossover point is reached when the CV indicator goes off and the CC indicator comes on.

Similarly, crossover from the constant current to the constant voltage mode automatically occurs from a decrease in load. A good example of this would be seen when charging a 12-volt battery. Initially, the open circuit voltage of the power supply may be preset for 13.8 volts. A low battery will place a heavy load on the supply and it will operate in the constant current mode, which may be adjusted for a 1 amp charging rate. As the battery becomes charged, and its voltage approaches 13.8 volts, its load decreases to the point where it no longer demands the full 1 amp charging rate. This is the crossover point where the power supply goes into the constant voltage mode.

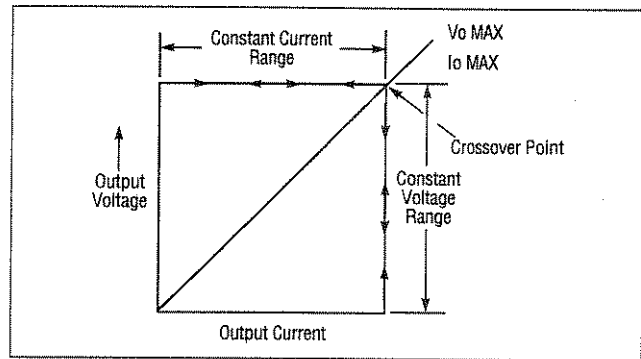

Figure 7. Constant Voltage/Constant Current Characteristics

CONNECTING TWO POWER SUPPLIES IN SERIES

Two Model 1711 power supplies may be connected in series to provide a variable 0-120 volt output. In this configuration, two 1711's provide up to 2 amps. See Fig. 8 for the connection scheme.

When connected in series, the VOLTAGE controls of each power supply exercise control over a 0-60 volt range. Add the two V meter readings together to determine the total output voltage, or connect an external voltmeter across the load.

Load current may be monitored from either supply; the readings will be identical since they are connected in series. Also, since the supplies are connected in series, it is only necessary to set the current limit on one of the supplies; the other may be set for maximum.

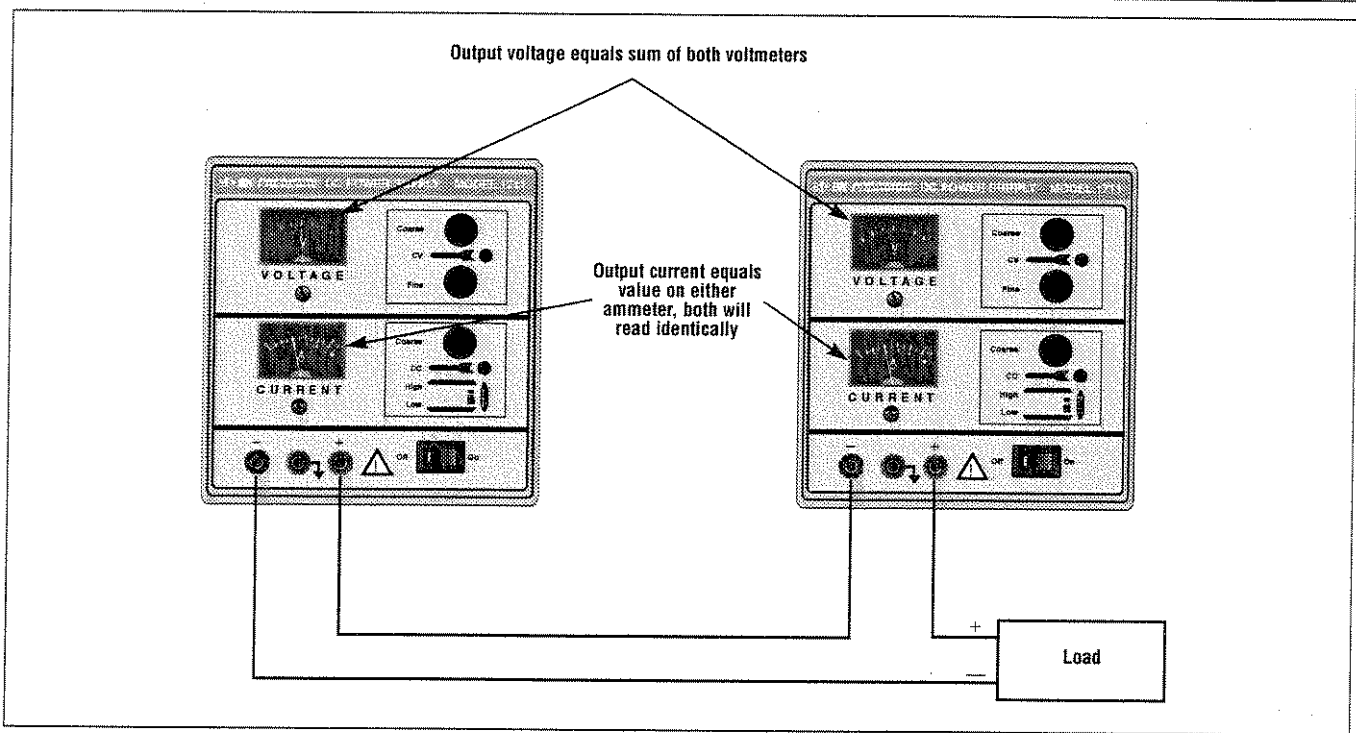

Figure 8. Connecting Two Power Supplies in Series.

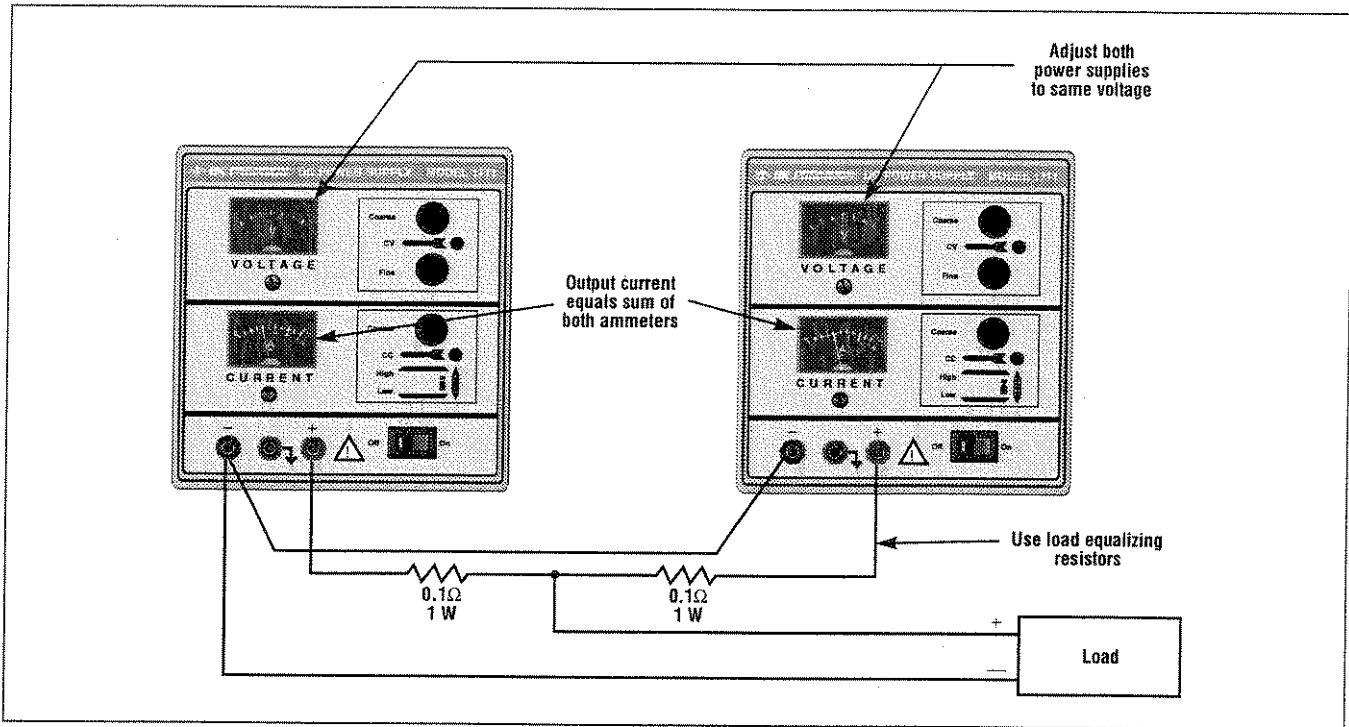

Figure 9. Connecting Two Power Supplies in Parallel.

APPLICATIONS

ELECTRONICS DESIGN LAB

The technician or engineer working in an engineering laboratory requires a dc power supply to power breadboard and prototype circuits. This power supply is ideal because it monitors both current and voltage simultaneously, limits current to protect the circuit, is adjustable over a wide range, and has excellent regulation and very low ripple.

Use of the instrument in an engineering laboratory is very similar to that described for servicing electronics equipment and modules, except that lower currents may be prevalent when powering individual circuits. The current limiting feature is very valuable in this application because it can protect unproven circuits from damage.

ELECTRONICS EDUCATION

The student in an electronics curriculum may use the power supply for powering equipment and circuits as previously described for all other applications. In addition, the power supply can be used in the classroom laboratory to conduct experiments in fundamental electronics. In learning Ohm's law, for example, the relationships of resistance, current, and voltage are vividly demonstrated by the use of a power supply. Being able to observe both the current and voltage meter simultaneously is a great aid in such experiments.

BATTERY CHARGING

The power supply can be used as a battery charger to restore the charge in rechargeable batteries such as lead-acid, nickel-cadmium, and some alkaline types. Refer to the battery manufacturer's charging specifications for proper voltage and current settings. Charging information is sometimes printed on the batteries. Battery charging, at least initially, requires the constant current mode of operation. Before connecting the power supply to the battery, preset the VOLTAGE controls to the fully charged terminal voltage specified by the battery manufacturer. Turn off the power supply while connecting the battery. Observe proper polarity and connect as for constant current operation. Adjust the CURRENT control for the maximum charging current specified by the battery manufacturer (If the maximum charging current is greater than the power supply's maximum load current, set the CURRENT control to maximum). The CC indicator will light and the battery will charge at the preset current limit, which can be read on the Δ meter. As the battery approaches full charge, its terminal voltage will approach that of the power supply output and the charging current will taper off. The power supply may automatically switch to CV (constant voltage) operation. When this occurs, the power supply will continue to provide a trickle charge.

MAINTENANCE

WARNING

The following instructions are for use by qualified personnel only. To avoid electrical shock, do not perform any servicing other than contained in the operating instructions unless you are qualified to do so.

FUSE REPLACEMENT

If the fuse blows, the CV or CC indicators will not light and the power supply will not operate. The fuse should not normally open unless a problem has developed in the unit. Try to determine and correct the cause of the blown fuse, then replace only with a fuse of the correct rating as listed below. The fuse is located on the rear panel (see Fig. 2).

OPERATION	FUSE VALUE	TYPE
120 V	2.0 A	SLOW BLOW
220/230/240 V	1.0 A	SLOW BLOW

Table 1. Fuse Values.

LINE VOLTAGE CONVERSION, INTERNATIONAL UNITS

The primary winding of the power transformer is tapped to permit operation from 120/220/230 or 240 VAC, 50/60 Hz line voltage. Con-

version from one line voltage to another is done by a simple wiring change as shown in Fig. 10.

A label on the rear panel identifies the line voltage to which the unit was factory wired. To convert to a different line voltage, perform the following procedure:

1. Make sure the power cord is unplugged.
2. Remove the case and locate the power transformer.
3. Rewire the power transformer to the desired line voltage as shown in Fig. 10.
4. A change in line voltage may also require a corresponding change of fuse value. Install the correct fuse value as listed in Table 1.
5. Replace the cover.
6. Affix a label showing the correct line voltage for the unit after conversion. Place this label directly over the factory label.

ADJUSTMENTS

This unit was accurately adjusted at the factory before shipment. Readjustment is recommended only if repairs have been made in a circuit affecting adjustment accuracy, or if you have a reason to believe the unit is out of adjustment. However, adjustments should be attempted only if a multimeter with an accuracy of $\pm 0.5\%$ DCV or better is available (B+K Precision Model 2703A or equivalent).

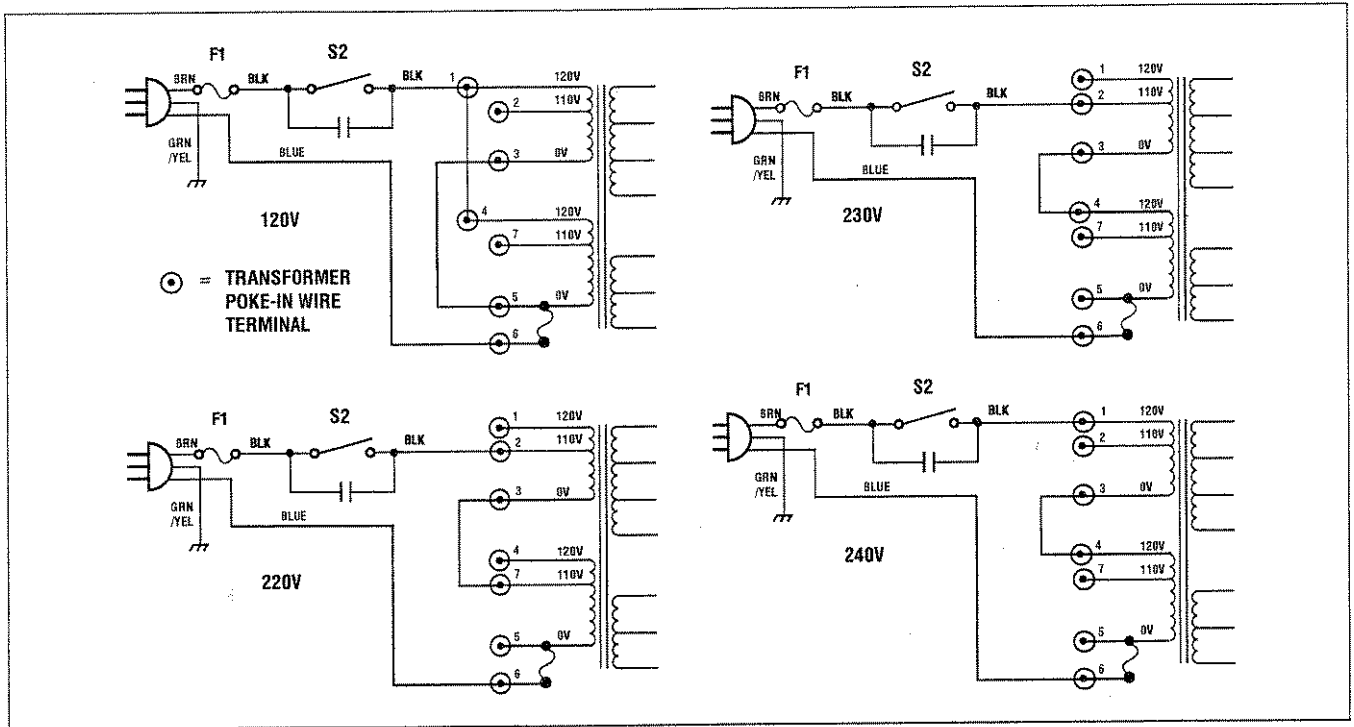

Figure 10. Line Voltage Conversion, International Units

1711 CALIBRATION

If readjustment is required, use the following procedure. Locations of the adjustments are shown in Fig. 11. The meters may be mechanically zeroed thru their front panel access holes prior to any calibration.

1. Set the front panel controls of the Model 1711 as follows:
Coarse and Fine **VOLTAGE** controls fully clockwise.
Coarse **CURRENT** control fully clockwise.
High-Low switch to **Low**.
Power switch to **On**.
2. Connect the multimeter to measure the voltage at pin 7 of IC2 with respect to the front panel red (+) output jack. Adjust **R21** for -5.00 volts on the multimeter.
3. Connect the multimeter to measure the voltage at pin 1 of IC2 with respect to the front panel red (+) output jack. Adjust **R63** for $0 \pm 10 \text{mV}$ on the multimeter.
4. Connect the multimeter to measure the DC voltage between the black (-) and red (+) output jacks. The voltage should be 60 to 63 volts, the green **CV** indicator should be lit, and the red **CC** indicator should be off.
5. Set the front panel Fine **VOLTAGE** control for a reading of 60.0 volts on the multimeter. Adjust **R54** for a front panel meter reading of 60 volts on the **VOLTAGE** meter.
6. Set the front panel Coarse **VOLTAGE** control for a reading of 10 volts on the **VOLTAGE** meter.
7. Set High-Low switch to **High**.
8. Connect the multimeter to read the DC current between the black (-) and red (+) output jacks, using the 10 amp range. The red **CC** indicator should light and the green **CV** indicator should go off.
9. Set the front panel Coarse **CURRENT** control for a reading of 2.00 amps on the multimeter. Adjust **R56** for a front panel meter reading of 2 amps on the **CURRENT** meter.
10. Set the High-Low switch to **Low**, the multimeter should read 0.50 ± 2 counts.

INSTRUMENT REPAIR SERVICE

Because of the specialized skills and test equipment required for instrument repair and calibration, many customers prefer to rely upon **B+K Precision** for this service. We maintain a network of **B+K Precision** authorized service agencies for this purpose. To use this service, even if the instrument is no longer under warranty, follow the instructions in the **WARRANTY SERVICE INSTRUCTIONS** section of this manual. There is a nominal charge for instruments out of warranty.

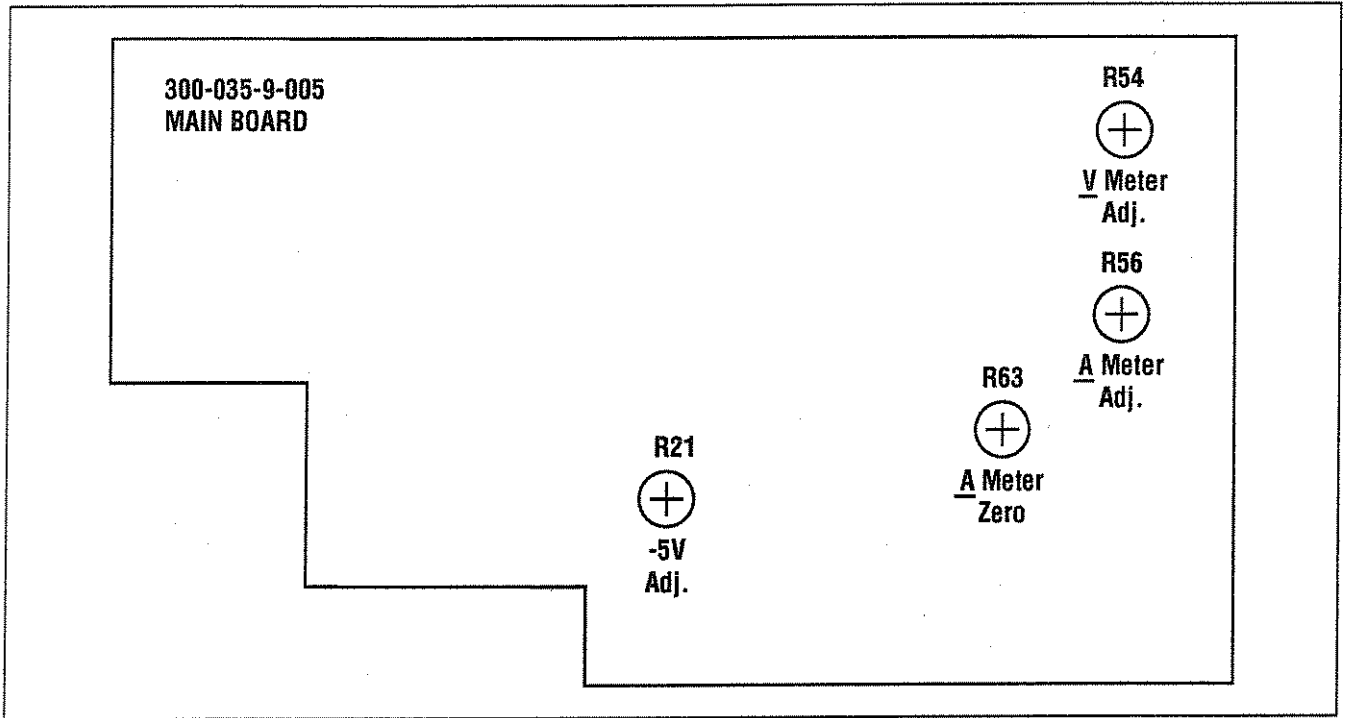

Figure 11. Location of Adjustments.